



Outline

Web Developpement
Dr. Nadine ZBIB

**CSS: Cascading Style
Sheets**

A thick, dark blue horizontal bar with rounded ends, positioned below the main title.

Objectives

- Topics covered:
 - using a style sheet to give all the pages of a Web site the same look and feel.
 - style sheet types and cascade precedence
 - CSS syntax for assigning style properties
 - Class selector and using the `class` attribute to apply styles.
 - using style sheets to separate presentation from content.



Introduction

- Cascading Style Sheets (CSS)
 - Separation of structure from presentation
 - Relationship between the style formatting and the structure/content is no longer 1:1
 - multiple style sheets can be applied to the same Web page
 - Same style sheet can be applied to the multiple Web page



Multiple Levels of Style Definition

- Cascade Precedence: resolves conflicting style rules
 - Inline style sheets
 - Embedded sheets
 - External style sheets
 - Author vs. User



Inline Styles

- style information is directly attached to the HTML elements they affect
- higher cascade precedence than the other specification methods
- declaring an individual element's format:
 - Attribute `style`
 - CSS (style) property
 - Followed by a colon and a value





```
1 <?xml version = "1.0"?>
2 <!DOCTYPE html PUBLIC "-//W3C//DTD XHTML 1.1//EN"
3     "http://www.w3.org/TR/xhtml11/DTD/xhtml11.dtd">
4
5 <!-- Fig. 6.1: inline.html -->
6 <!-- Using inline styles -->
7
8 <html xmlns = "http://www.w3.org/1999/xhtml">
9     <head>
10         <title>Inline Styles</title>
11     </head>
12
13     <body>
14
15         <p>This text does not have any style applied to it.</p>
16
17         <!-- The style attribute allows you to declare -->
18         <!-- inline styles. Separate multiple styles -->
19         <!-- with a semicolon. -->
20         <p style = "font-size: 20pt">This text has the
21         <em>font-size</em> style applied to it, making it 20pt.
22         </p>
23
```



```
24 <p style = "font-size: 20pt; color: #0000ff">  
25 This text has the <em>font-size</em> and  
26 <em>color</em> styles applied to it, making it  
27 20pt. and blue.</p>  
28  
29 </body>  
30 </html>
```

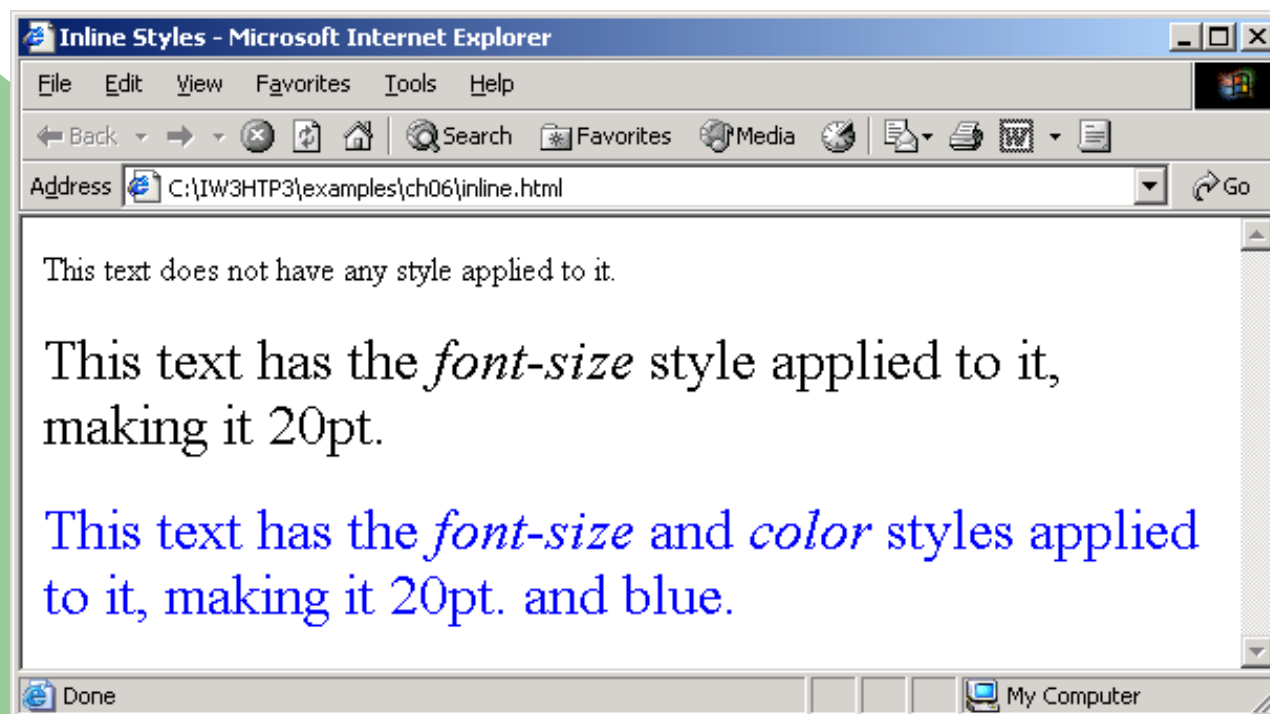

Embedded Style Sheets

- this method can only specify style information for the current document:
 - 1:1 relationship
 - However, the same document may have other style definitions applied to it
 - 1:M relationship
- embedded style sheet rule will have higher precedence than external style sheet rule, if there is a conflict between styles
- embedded style sheet rule will have lower precedence than an inline style sheet rule



Embedded Style Sheets

- Embed an entire CSS document in an XHTML document's head section inside a `style` element
 - Attribute type
 - Multipurpose Internet Mail Extensions (MIME) type
 - describes the type of the document's content
 - `text/css` is the type for CSS document
 - Style properties are defined for:
 - Existing defined elements, such as `p` (paragraph), `h3` (header), `li` (list) or any other
 - *Style class* that can be applied to either:
 - Any existing type of element in the body of the document or
 - One specific element in the document



CSS Syntax for Assigning Style Properties

- The CSS syntax is made up of three parts: a selector, a property and a value:
 - `selector {property: value}`
- A selector can be:
 - the HTML element/tag you wish to define. In this example:
 - `body {color: black}` , element `body` is the selector
 - The class selector, which can be tied to a specific element, such as:
 - `p.right {text-align: right}`
 - The class selector applicable to any element, such as:
 - `.loud {font-family: fantasy; font-size: xx-large}`
- If a class selector is used, it has to be invoked in the body of the XHTML document:
 - `<p class="right">` or
 - `<table class="loud">`



CSS Syntax for Assigning Style Properties: additional issues

- Group selectors are possible for a group of HTML elements. For example:
 - `h1,h2,h3,h4,h5,h6 {color: green}` will make all header elements text green
- When a class selector is defined for a particular element, it can not be invoked on other elements. Using example from the previous slide which of these uses of class styles in the XHTML document is correct?
 - `<ul class = "loud">`
 - `<ul class = "right">`
- Pseudo-class selectors define the style for the parts of a document based on some characteristics other than tag name, attributes or content. They may be defined by a user action such as:
 - Mouseover (hover pseudoclass)
 - Clicking (active pseudoclass)



CSS syntax: continue

- Invoking a style class to a block of text not defined by a particular element
 - span element
 - div element (block level element)



Style Inheritance and Conflict Resolution

- Inheritance
 - An element that is present within another element (child) inherits all style properties from its “parent” element
 - However, if such child (or descendant) element has properties that conflict with defined properties of its parent element, conflict is resolved in favors of properties of a child element
 - Child element properties have greater *specificity* than ancestor’s properties





```
1 <?xml version = "1.0"?>
2 <!DOCTYPE html PUBLIC "-//W3C//DTD XHTML 1.1//EN"
3   "http://www.w3.org/TR/xhtml11/DTD/xhtml11.dtd">
4
5 <!-- Fig. 6.2: declared.html -->
6 <!-- Declaring a style sheet in the header section. -->
7
8 <html xmlns = "http://www.w3.org/1999/xhtml">
9   <head>
10    <title>style sheets</title>
11
12    <!-- this begins the style sheet section -->
13    <style type = "text/css">
14
15        em      { background-color: #8000ff;
16                  color: white }
17
18        h1      { font-family: arial, sans-serif }
19
20        p      { font-size: 14pt }
21
22        .special { color: blue }
23
24    </style>
25 </head>
```

← Style Class selector:
applicable to any element in
this document





26 <body>

27 <!-- this class attribute applies the .special style -->

28 <h1 class = "special">Deitel & Associates, Inc.</h1>

← Style Class “special”
invoked for h1 element

31 <p>Deitel & Associates, Inc. is an internationally
32 recognized corporate training and publishing organization
33 specializing in programming languages, Internet/world
34 wide web technology and object technology education.
35 Deitel & Associates, Inc. is a member of the world wide
36 Web Consortium. The company provides courses on Java,
37 C++, Visual Basic, C, Internet and world wide web
38 programming, and Object Technology.</p>

40 <h1>Clients</h1>

41 <p class = "special"> The company's clients include many
42 Fortune 1000 companies, government agencies,
43 branches of the military and business organizations.
44 Through its publishing partnership with Prentice Hall,
45 Deitel & Associates, Inc. publishes leading-edge
46 programming textbooks, professional books, interactive
47 CD-ROM-based multimedia Cyber Classrooms, satellite
48 courses and world wide web courses.</p>

← Style Class “special”
invoked for p element



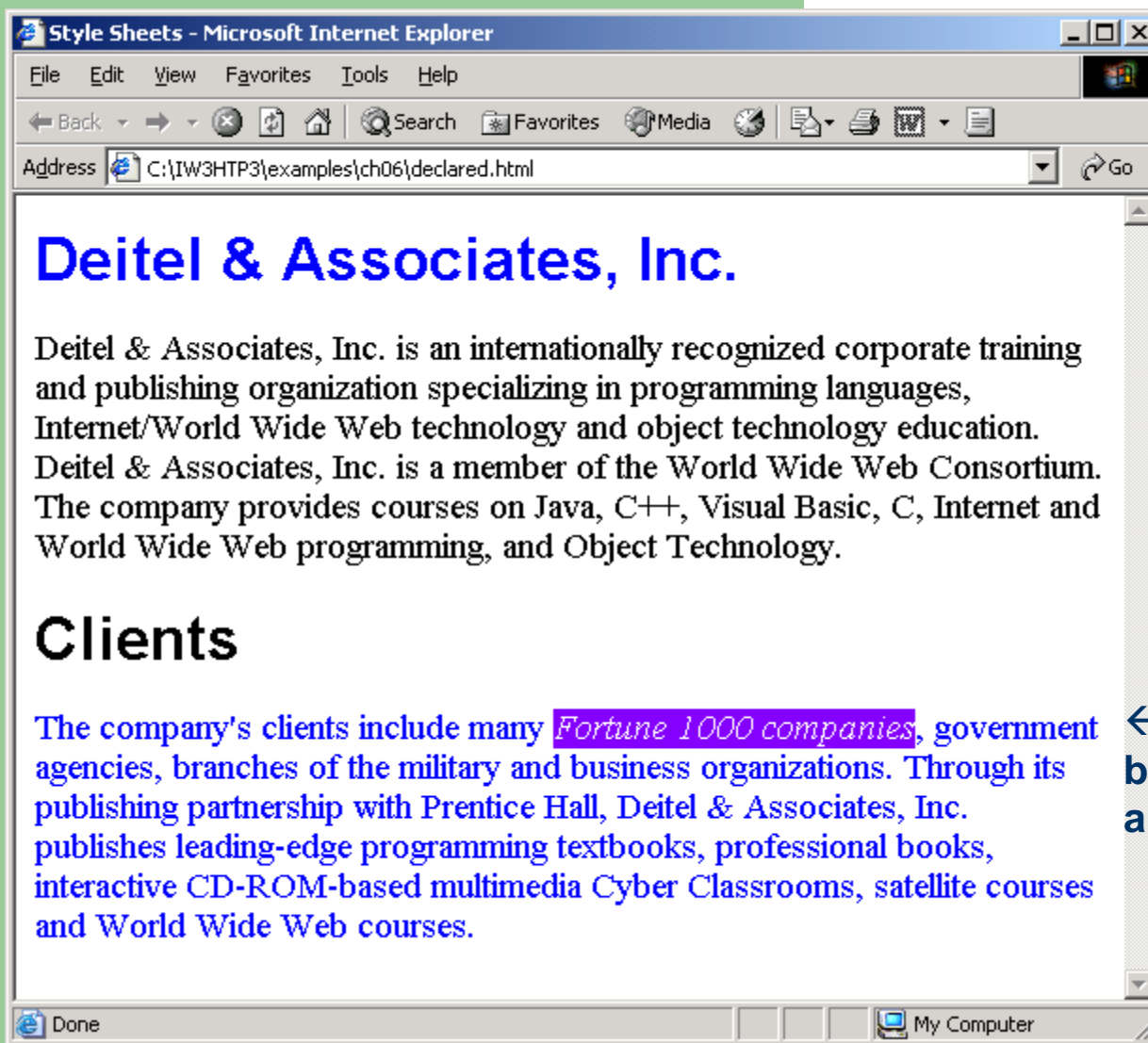

← color Conflict resolution between parent element p and child element em



```
1 <?xml version = "1.0"?>
2 <!DOCTYPE html PUBLIC "-//W3C//DTD XHTML 1.1//EN"
3   "http://www.w3.org/TR/xhtml11/DTD/xhtml11.dtd">
4
5 <!-- Fig 6.3: advanced.html -->
6 <!-- More advanced style sheets -->
7
8 <html xmlns = "http://www.w3.org/1999/xhtml">
9   <head>
10    <title>More Styles</title>
11
12    <style type = "text/css">
13
14      a.nodect { text-decoration: none }
15
16      a:hover { text-decoration: underline;
17                color: red;
18                background-color: #ccffcc }
19
20      li em { color: red;
21              font-weight: bold }
22
23      ul { margin-left: 75px }
```

← Style Class: applicable only to element a in this document

← Pseudoclass: applicable only to element a in this document. (note different syntax)

← This is NOT a group selector. It declares that this specific style is applicable to em elements inside an li element



```
25     ul ul      { text-decoration: underline;
26                 margin-left: 15px }
27
28     </style>
29 </head>
30
31 <body>
32
33     <h1>Shopping list for <em>Monday</em>:</h1>
34
35     <ul>
36         <li>Milk</li>
37         <li>Bread
38             <ul>
39                 <li>white bread</li>
40                 <li>Rye bread</li>
41                 <li>whole wheat bread</li>
42             </ul>
43         </li>
44         <li>Rice</li>
45         <li>Potatoes</li>
46         <li>Pizza <em>with mushrooms</em></li>
47     </ul>
48
```



Outline



49 <p>

50 Go to the Grocery store</p>

52 </body>

53 </html>



Outline

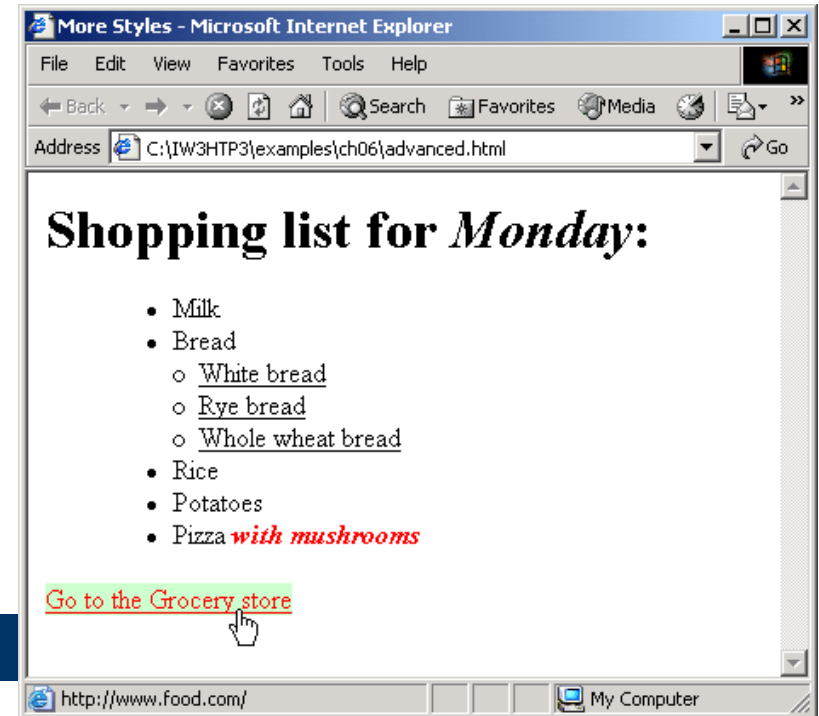
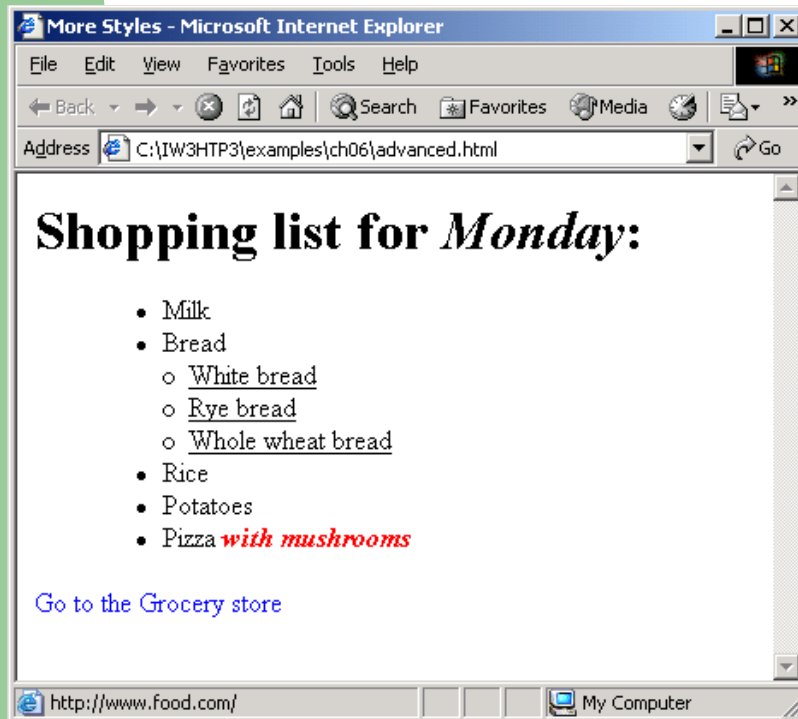

External Style Sheets

- External style sheets
 - Applicable to more than document
 - Documents can have more than one source for style specification
 - M:M relationship
- Can provide uniform look and feel to entire site
- Same CSS syntax rules for assigning and invoking style properties apply



External Style Sheets

- Location (`href`) and type (`type`) of the external style sheet are specified as attributes of a `link` element in the head portion of an XHTML document
- In addition, the `rel` attribute specifies the nature of the relationship between the stylesheet and the document that is referencing it
 - Persistent stylesheets must be applied to the document
 - Preferred style sheet should be applied unless the user has selected a different alternate
 - Alternate style sheets may be selected by users depending on their preferences



Linking External Style Sheets

- To make a style sheet *persistent*, set the `rel` attribute to "stylesheet".
- To make a style sheet *preferred*, set the `rel` attribute to "stylesheet" and name the style sheet with the additional `title` attribute.
- To specify an *alternate* style sheet, set the `rel` attribute to "alternate stylesheet" and name the style sheet with the `title` attribute.



```
1 /* Fig. 6.4: styles.css */
2 /* An external stylesheet */
3
4 a      { text-decoration: none }
5
6 a:hover { text-decoration: underline;
7           color: red;
8           background-color: #ccffcc }
9
10 li em  { color: red;
11         font-weight: bold;
12         background-color: #ffffff }
13
14 ul     { margin-left: 2cm }
15
16 ul ul  { text-decoration: underline;
17         margin-left: .5cm }
```



Outline





```
1 <?xml version = "1.0"?>
2 <!DOCTYPE html PUBLIC "-//W3C//DTD XHTML 1.1//EN"
3   "http://www.w3.org/TR/xhtml11/DTD/xhtml11.dtd">
4
5 <!-- Fig. 6.5: external.html -->
6 <!-- Linking external style sheets -->
7
8 <html xmlns = "http://www.w3.org/1999/xhtml">
9   <head>
10     <title>Linking External Style Sheets</title>
11     <link rel = "stylesheet" type = "text/css"
12       href = "styles.css" />
13   </head>
14
15   <body>
16
17     <h1>Shopping list for <em>Monday</em>:</h1>
18     <ul>
19       <li>Milk</li>
20       <li>Bread
21         <ul>
22           <li>white bread</li>
23           <li>Rye bread</li>
24           <li>whole wheat bread</li>
25         </ul>

```

Outline

```
26         </li>
27         <li>Rice</li>
28         <li>Potatoes</li>
29         <li>Pizza <em>with mushrooms</em></li>
30     </ul>
31
32     <p>
33     <a href = "http://www.food.com">Go to the Grocery store</a>
34     </p>
35
36 </body>
37 </html>
```

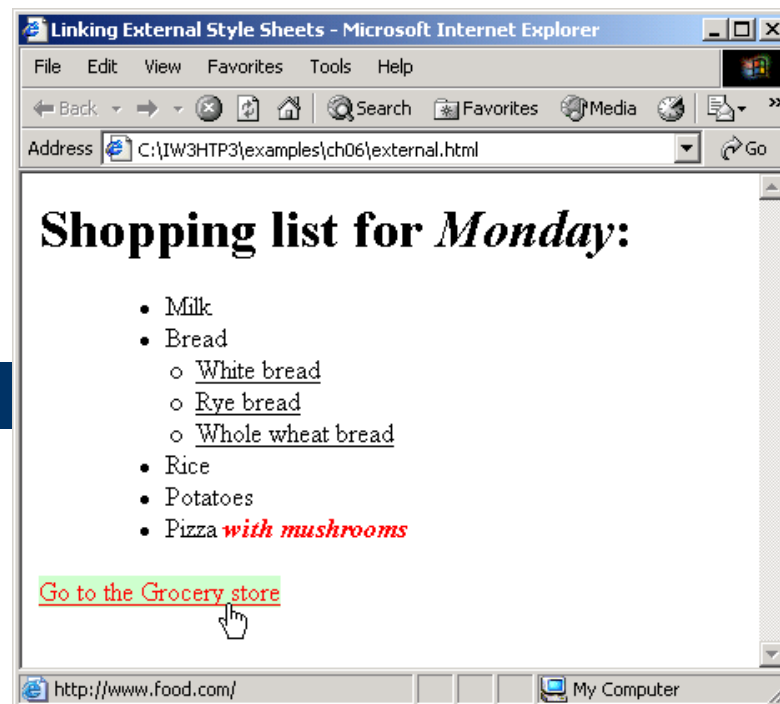
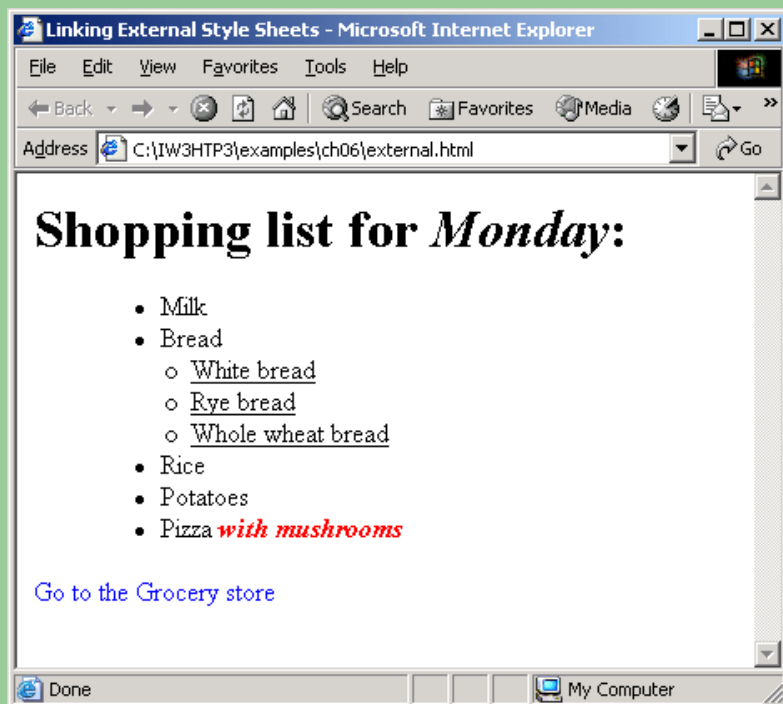

W3C CSS Validation Service

- Validates external CSS documents
- Ensures that style sheets are syntactically correct
- <http://jigsaw.w3.org/css-validator/>



6.10 Text Flow and the Box Model

- Floating
 - Move an element to one side of the screen
- Box model
 - Margins
 - Padding
 - Border





```
1 <?xml version = "1.0"?>
2 <!DOCTYPE html PUBLIC "-//W3C//DTD XHTML 1.1//EN"
3   "http://www.w3.org/TR/xhtml11/DTD/xhtml11.dtd">
4
5 <!-- Fig. 6.12: floating.html      -->
6 <!-- Floating elements and element boxes -->
7
8 <html xmlns = "http://www.w3.org/1999/xhtml">
9   <head>
10    <title>Flowing Text Around Floating Elements</title>
11
12    <style type = "text/css">
13
14      div { background-color: #ffccff;
15            margin-bottom: .5em;
16            font-size: 1.5em;
17            width: 50% }
18
19      p   { text-align: justify }
20
21    </style>
22
23  </head>
24
```



25 <body>

26
27 <div style = "text-align: center">
28 Deitel & Associates, Inc.</div>

29
30 <div style = "float: right; margin: .5em;
31 text-align: right">
32 Corporate Training and Publishing</div>

33
34 <p>Deitel & Associates, Inc. is an internationally
35 recognized corporate training and publishing organization
36 specializing in programming languages, Internet/world
37 wide web technology and object technology education.
38 The company provides courses on Java, C++, Visual Basic, C,
39 Internet and world wide web programming, and Object Technology.</p>

40
41 <div style = "float: right; padding: .5em;
42 text-align: right">
43 Leading-Edge Programming Textbooks</div>

44
45 <p>The company's clients include many Fortune 1000
46 companies, government agencies, branches of the military
47 and business organizations.</p>



Outline



```
49 <p style = "clear: right">Through its publishing
50 partnership with Prentice Hall, Deitel & Associates,
51 Inc. publishes leading-edge programming textbooks,
52 professional books, interactive CD-ROM-based multimedia
53 Cyber Classrooms, satellite courses and world wide web
54 courses.</p>
55
56 </body>
57 </html>
```



Outline

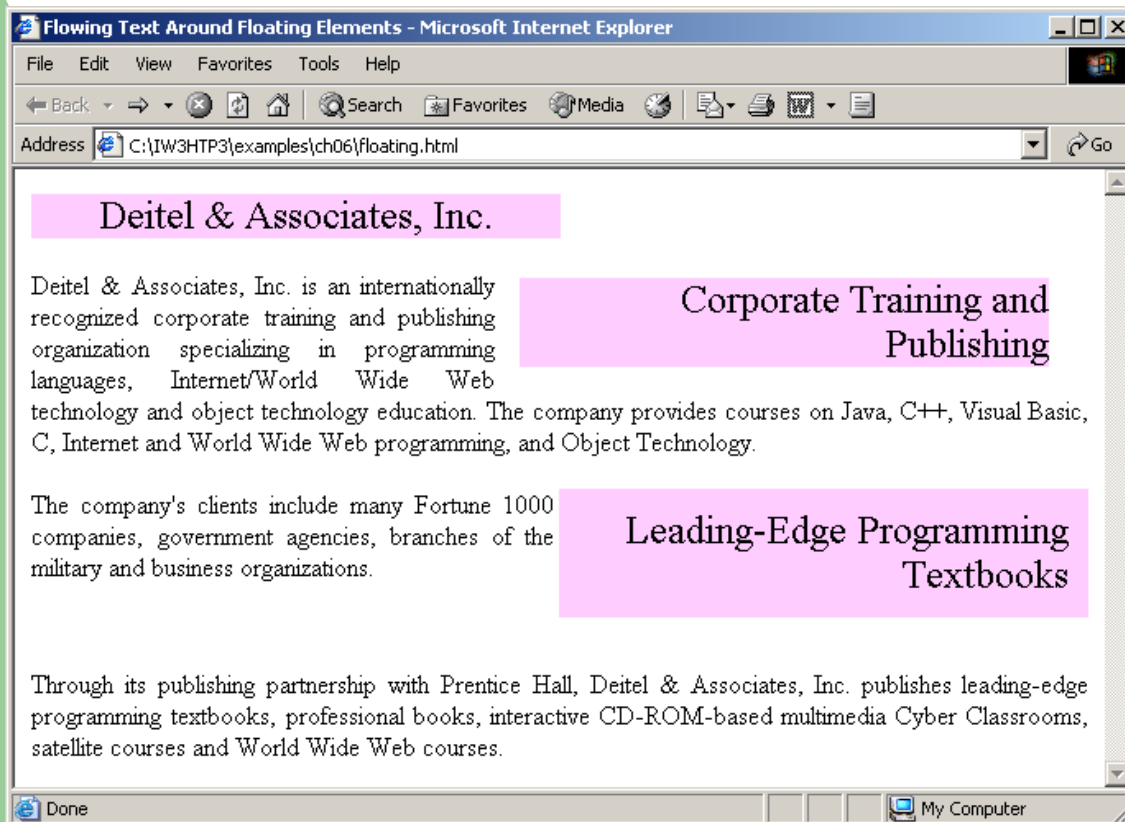

Text Flow and the Box Model

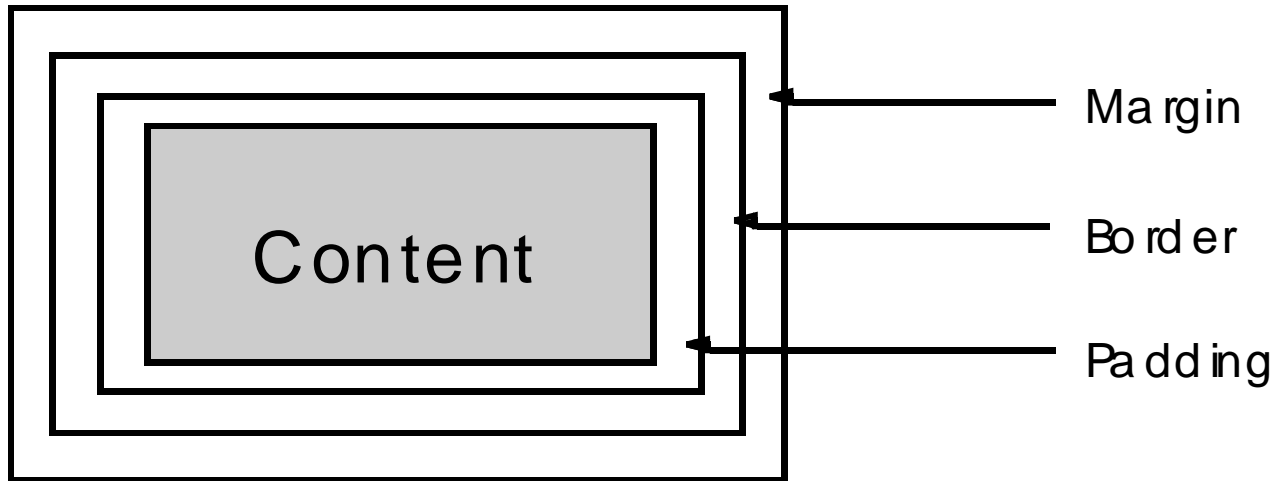



```
1 <?xml version = "1.0"?>
2 <!DOCTYPE html PUBLIC "-//W3C//DTD XHTML 1.1//EN"
3     "http://www.w3.org/TR/xhtml11/DTD/xhtml11.dtd">
4
5 <!-- Fig. 6.14: borders.html      -->
6 <!-- Setting borders of an element -->
7
8 <html xmlns = "http://www.w3.org/1999/xhtml">
9     <head>
10         <title>Borders</title>
11
12         <style type = "text/css">
13
14             body    { background-color: #ccffcc }
15
16             div     { text-align: center;
17                     margin-bottom: 1em;
18                     padding: .5em }
19
20             .thick  { border-width: thick }
21
22             .medium { border-width: medium }
23
24             .thin   { border-width: thin }
25
```





```
26     .groove { border-style: groove }
27
28     .inset  { border-style: inset  }
29
30     .outset { border-style: outset }
31
32     .red    { border-color: red   }
33
34     .blue   { border-color: blue  }
35
36 </style>
37 </head>
38
39 <body>
40
41     <div class = "thick groove">This text has a border</div>
42     <div class = "medium groove">This text has a border</div>
43     <div class = "thin groove">This text has a border</div>
44
45     <p class = "thin red inset">A thin red line...</p>
46     <p class = "medium blue outset">
47         And a thicker blue line</p>
48
49 </body>
50 </html>
```



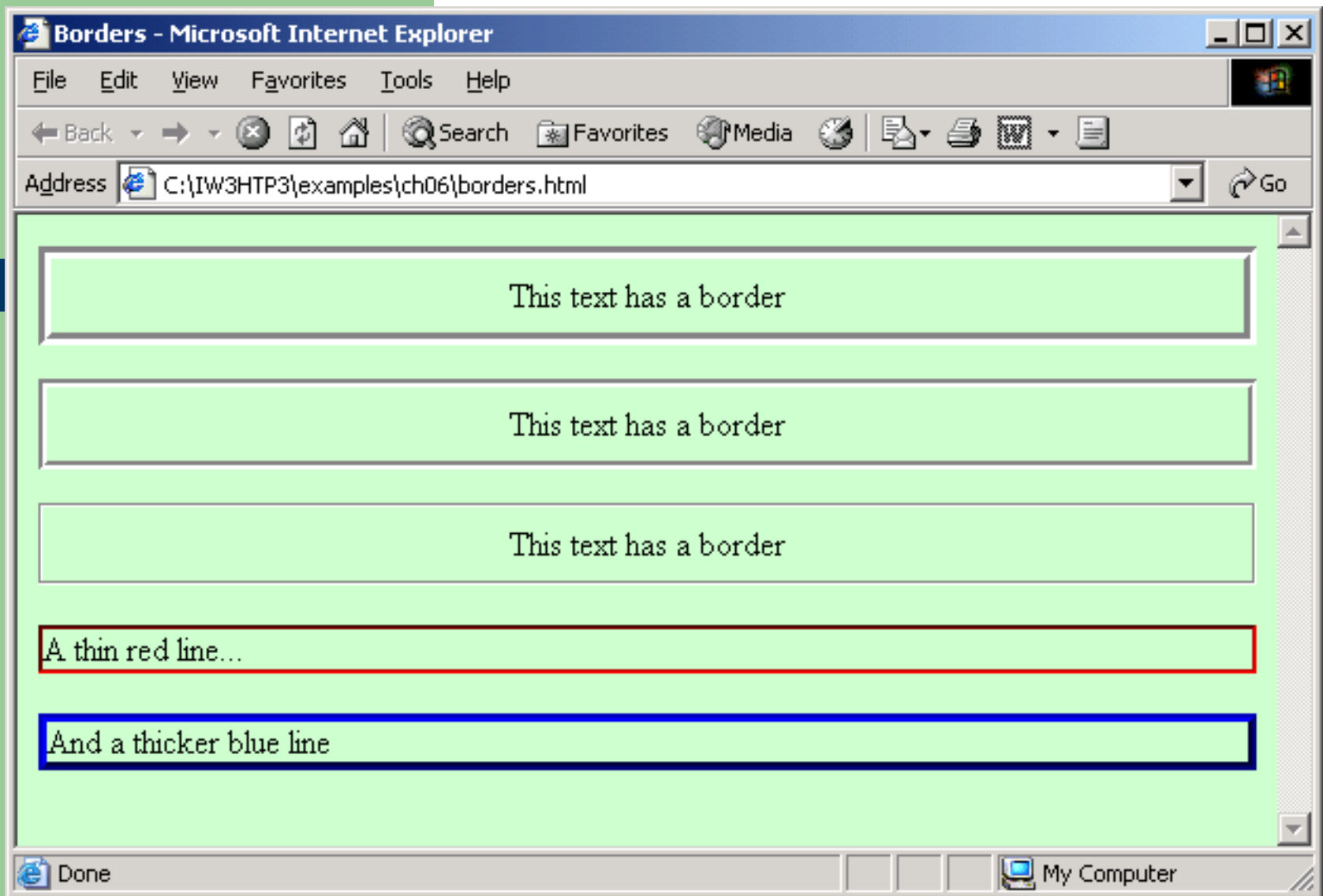

User Style Sheets

- Format pages based on user preferences
- User style sheets are not linked in the document
 - They are set in browser's options





```
1 <?xml version = "1.0"?>
2 <!DOCTYPE html PUBLIC "-//W3C//DTD XHTML 1.1//EN"
3   "http://www.w3.org/TR/xhtml11/DTD/xhtml11.dtd">
4
5 <!-- Fig. 6.16: user_absolute.html -->
6 <!-- User styles -->
7
8 <html xmlns = "http://www.w3.org/1999/xhtml">
9   <head>
10     <title>User Styles</title>
11
12     <style type = "text/css">
13
14       .note { font-size: 9pt }
15
16     </style>
17 </head>
18
19 <body>
20
21   <p>Thanks for visiting my web site. I hope you enjoy it.
22   </p><p class = "note">Please Note: This site will be
23   moving soon. Please check periodically for updates.</p>
```

24

25 </body>

26 </html>



Outline

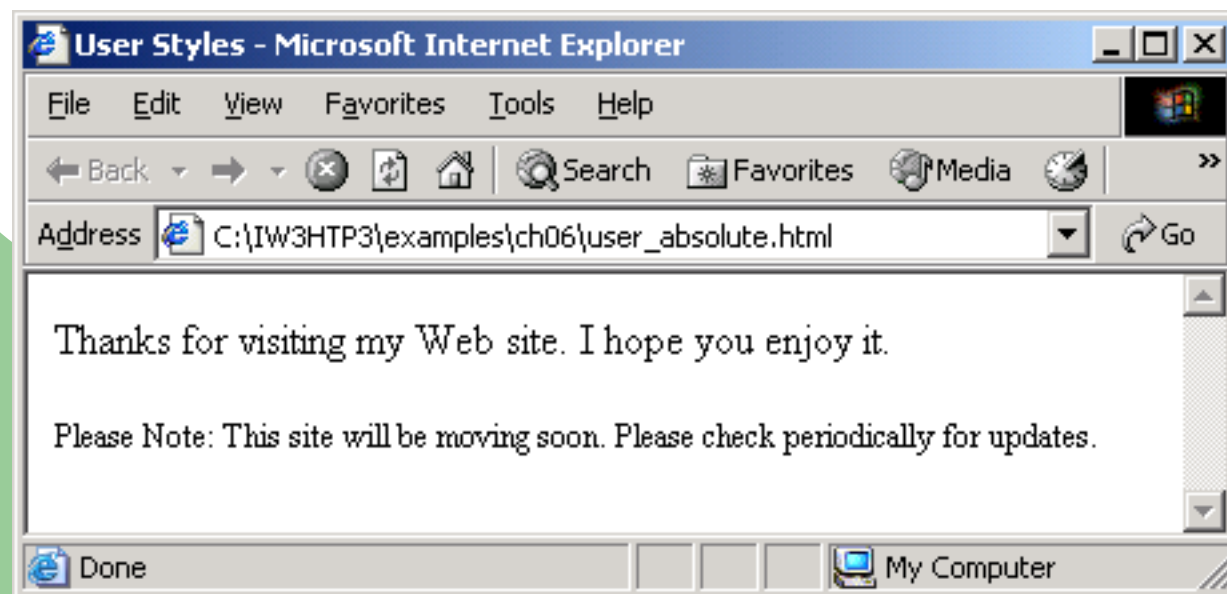

```
1 /* Fig. 6.17: userstyles.css */
2 /* A user stylesheet */
3
4 body { font-size: 20pt;
5         color: yellow;
6         background-color: #000080 }
```



Outline



User Style Sheets

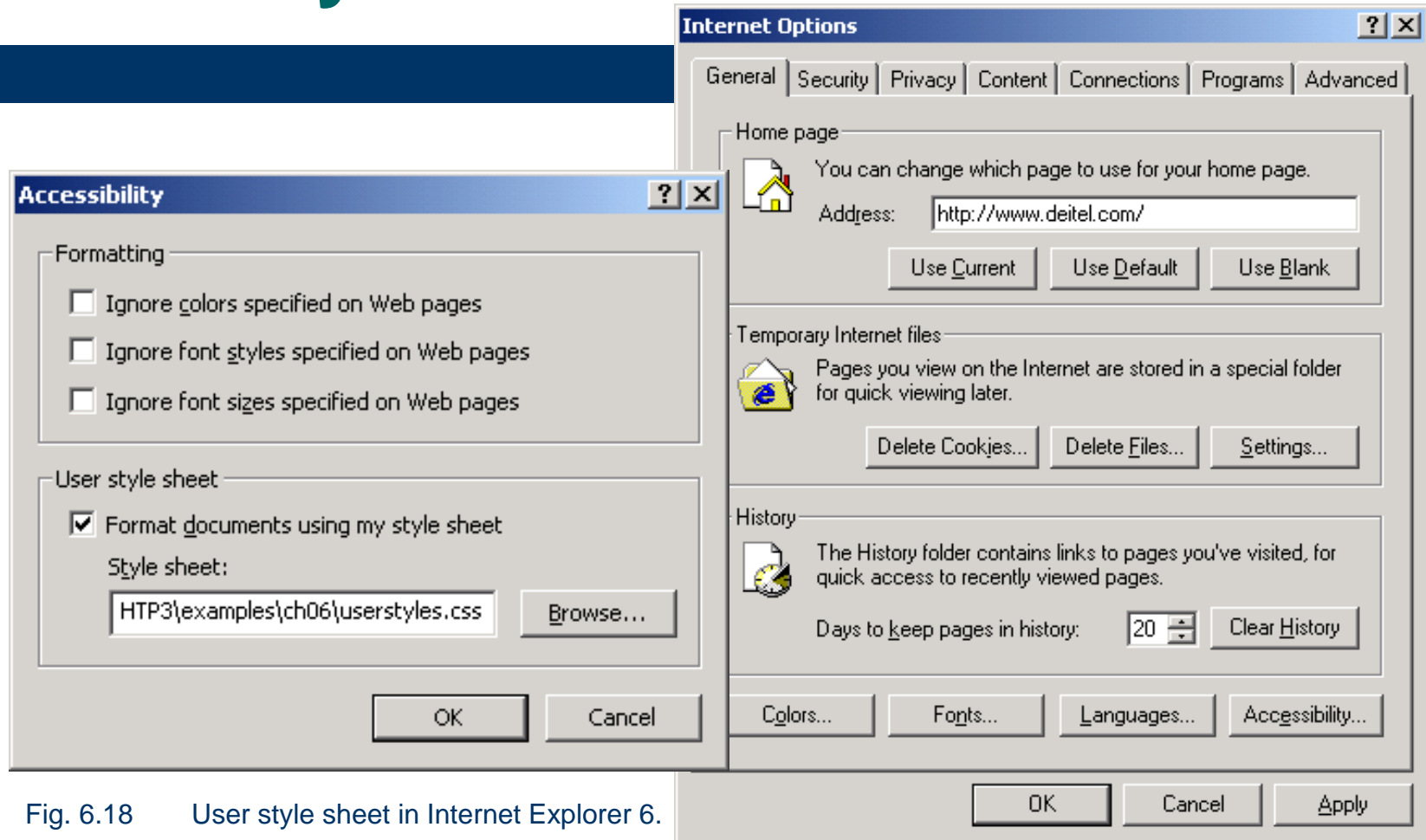
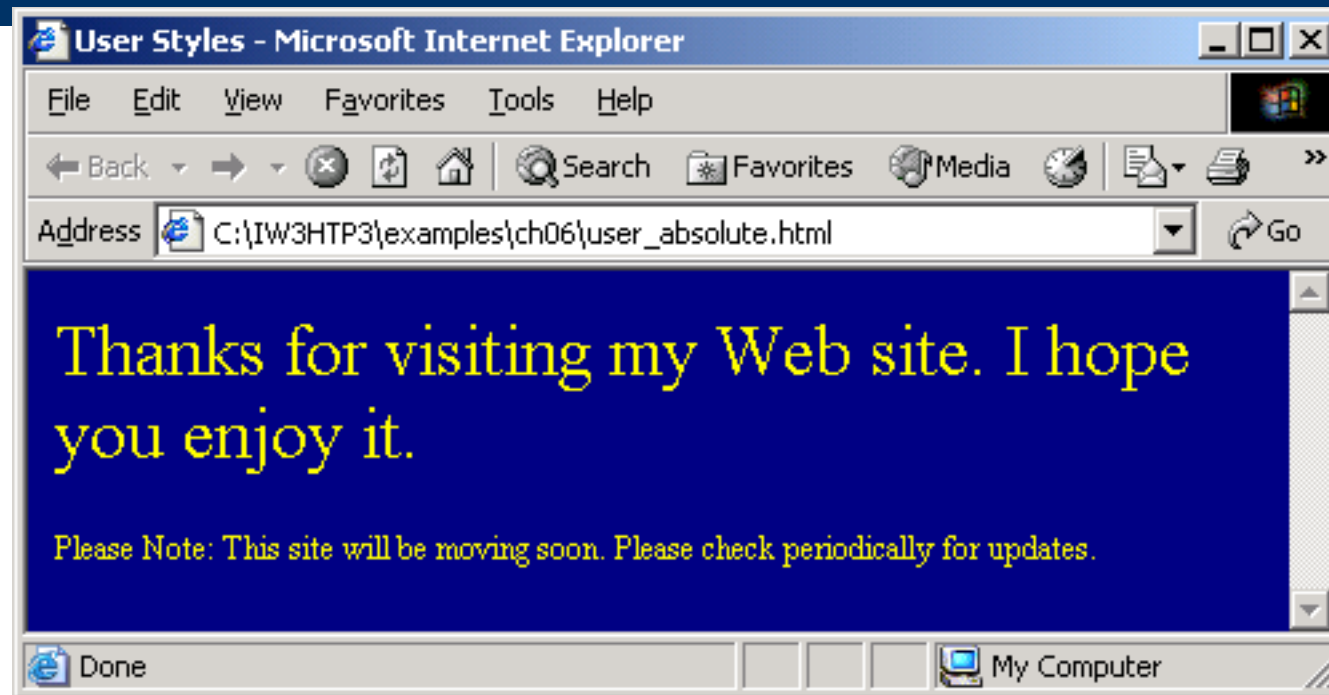

Fig. 6.18 User style sheet in Internet Explorer 6.



User Style Sheets





```
1 <?xml version = "1.0"?>
2 <!DOCTYPE html PUBLIC "-//W3C//DTD XHTML 1.1//EN"
3     "http://www.w3.org/TR/xhtml11/DTD/xhtml11.dtd">
4
5 <!-- Fig. 6.20: user_relative.html -->
6 <!-- User styles -->
7
8 <html xmlns = "http://www.w3.org/1999/xhtml">
9     <head>
10         <title>User Styles</title>
11
12         <style type = "text/css">
13
14             .note { font-size: .75em }
15
16         </style>
17     </head>
18
19     <body>
20
21         <p>Thanks for visiting my web site. I hope you enjoy it.
22         <p class = "note">Please Note: This site will be
23         moving soon. Please check periodically for updates.</p>
```



24

</body>

26 </html>



Outline

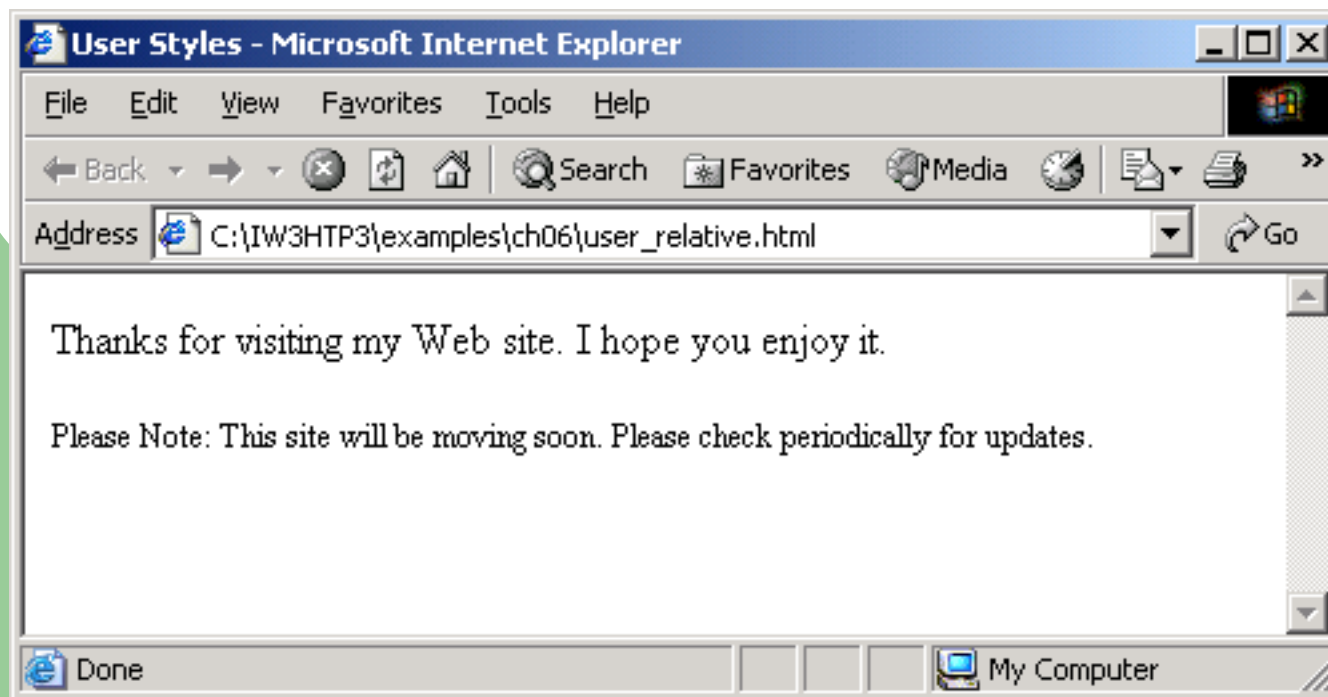

User Style Sheets

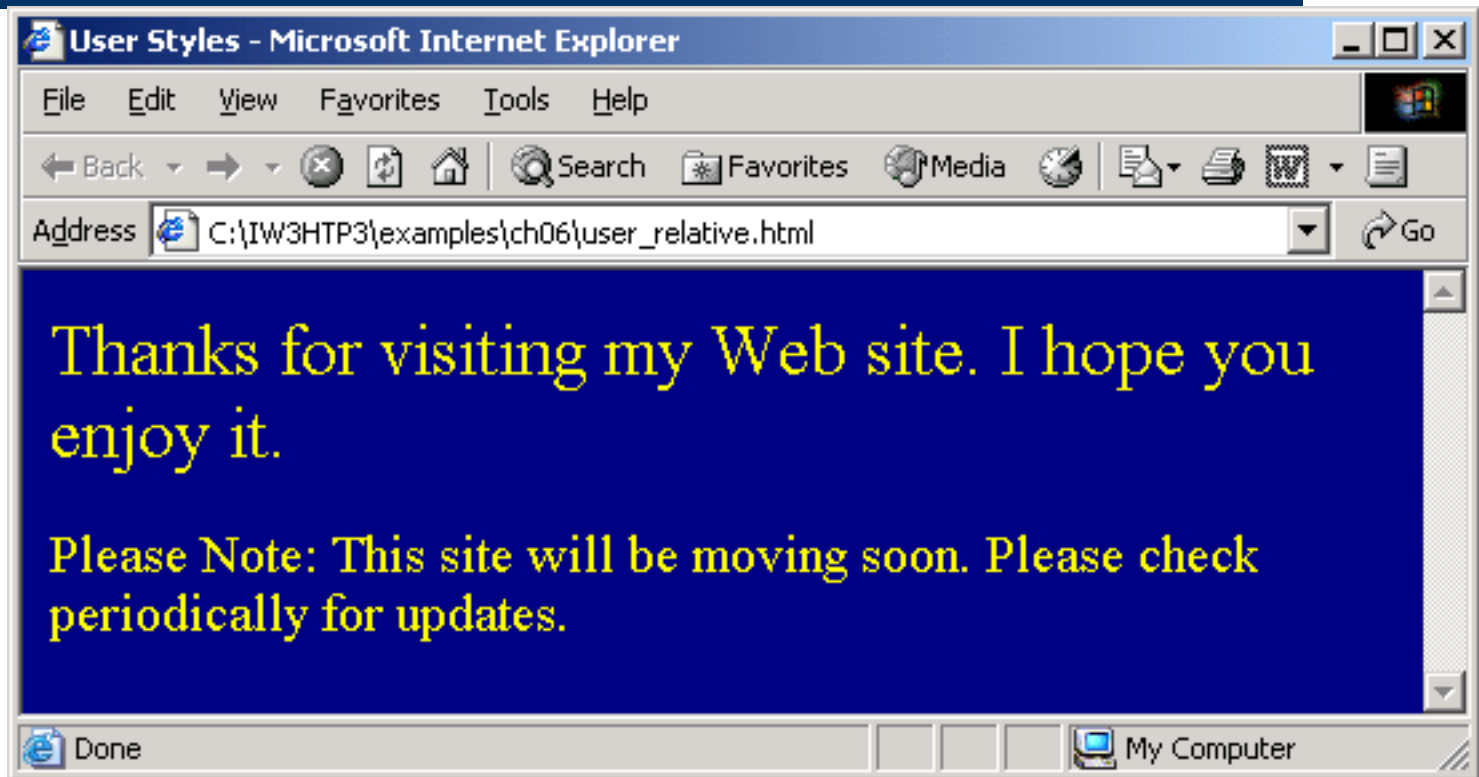

Fig. 6.21 User style sheet applied with em measurement.

